

REACH & RoHS
COMPLIANT

REV.	ECN / DESCRIPTION	BY	DATE
A0	NEW	ZG.HU	2017.12.20

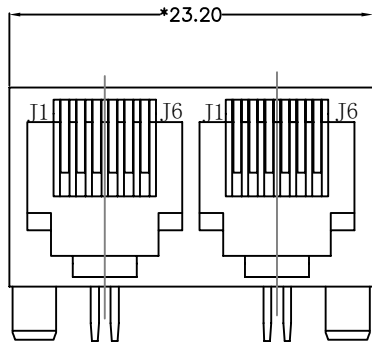

FRONT VIEW

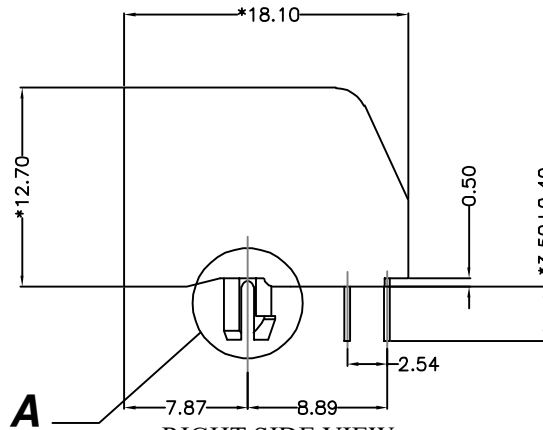

RIGHT SIDE VIEW

MATERIAL:
HOUSING: PBT,UL94V-0,BLACK.
TERMINAL: PHOSPHOR BRONZE T=0.35MM.
15U" GOLD PLATING ON CONTACT AREA.

MACHANICAL:
DURABILITY: 750 CYCLES MIN,12.5MM/MINUTE.
INSERTION FORCE: 2.2KG.F MAX.
RETENTION STRENGTH : 7.7KG.F BETWEEN JACK AND PLUG.
OPERATING TEMPERATURE: -40°C~+85°C.
STORAGE TEMPERATURE: -40°C~+85°C.
ALL CRITICAL DIMENSIONS WITH "**"

ELECTRICAL:
VOLTAGE: 125 VOLTS AC.
CURRENT RATING : 1.5AMP.
DIELECTRIC STRENGTH: 1000 VAC RMS 50HZ OR 60HZ,1MIN.
INSULATION RESISTANCE: 500 MEGA OHMS MIN. INITIAL
AFTER 500V DC FOR 1 MINUTE.
CONTACT RESISTANCE: SINGLE TERMINAL 30 MILLIOHMS MAX.
INITIAL 50 MILLIOHMS MAX. AFTER
DURABILITY TEST.

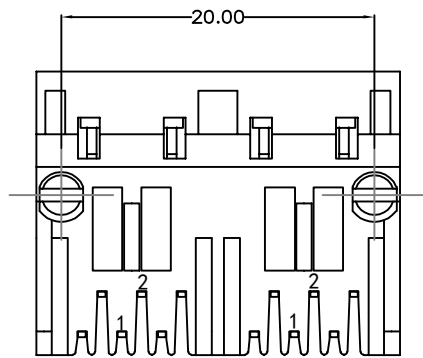

BOTTOM VIEW

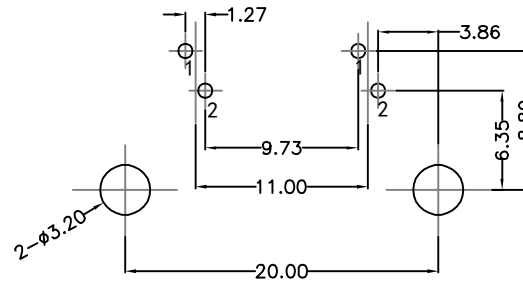

RECOMMENDED PCB LAYOUT
VIEWED FROM COMPONENT SIDE

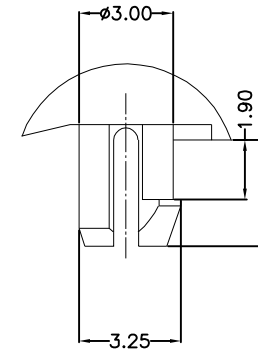

A(2:1)

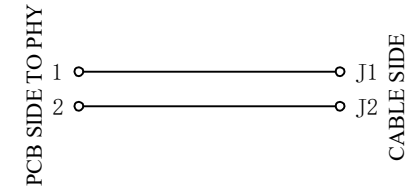

DGKYD

东莞市科优达电子科技有限公司
Dong Guan Ke You Da Electronic Tech.Co.,Ltd

Tel:+86-0769-87334608; Fax:+86-0769-87847129 WWW.DGKYD.COM

TITLE:
5722 1*2 6P2C 无耳朵 全塑

PART NO.:
DGKYD57221262IWA1DB5

REMARK:

SIZE
A4

SACLE
1:1

SHEET
1/1

UNITS
MM[INCH]

REV
A0

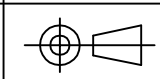

GENERAL TOLERANCES
UNLESS SPECIFIED

x±0.35
.x±0.30
.xx±0.25
.xxx±0.10

APPROVED BY:
JP.Gong

CHECKED BY:
TW.Xu

DESIGND BY:
ZG.Hu